

ALTER SOFT LIGHTS **QVS2GPFOS2FT 2X50W**

2' X 2' RECESSED DIRECT/INDIRECT FLUORESCENT
2 LAMP, TT5 BI-TUBE, 5 1/2" DEEP
MICROPERFORATED MESH LAMP SHIELD, STATIC

Features

- Efficiency 51.2%.
- Swing down microperforated lamp shield for easy relamping and maintenance.
- Alter soft white film on inside of mesh conceals lamp image providing balance between reflected and direct light.
- Fully recessed luminaire and lamp compartment.
- 95% Reflective Alter soft white paint finish.
- Specular interior reflector.
- One piece body for easy installation.
- Exclusive socket locks lamp into place.
- Easy access to ballast through lamp compartment.
- Fits standard T-Grid ceilings.
- Optional acrylic drop-down visual element.



Mounting Methods / Features

Ceiling compatibility

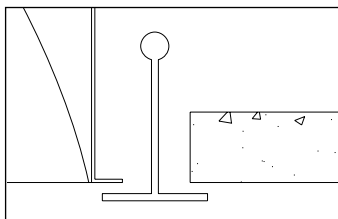

Suited to standard exposed T-grid ceilings

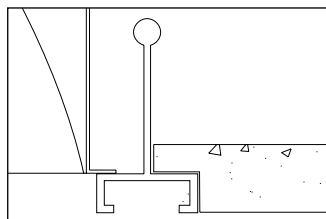

Suited to standard exposed Slot T-grid ceilings

Swing down optical system for easy relamping and maintenance



Microperforated mesh lamp shields

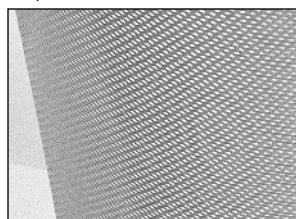

Also available with solid opaque swing-down lamp shield

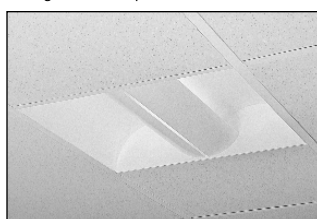

Dimensions

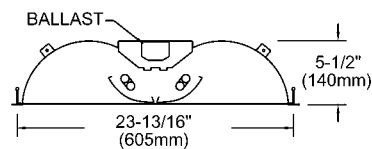
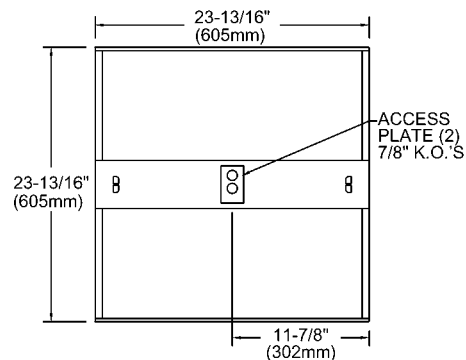

Job Information

Type:

Job Name:

Cat. No.:

Lamp(s):

Volts/Ballast:

Lightolier a Genlyte Thomas Company

www.lightolier.com

Technical Information: (978) 657-7600 • Fax (978) 658-0595
631 Airport Road, Fall River, MA 02720 • (508) 679-8131 • Fax (508) 674-4710

We reserve the right to change details of design, materials and finish.

© 2002 Genlyte Thomas Group LLC (Lightolier Division)

A0902

Section 5 / Folio L10-20

LIGHTOLIER®

ALTER SOFT LIGHTS QVS2GPFOS2FT 2X50W

2' X 2' RECESSED DIRECT/INDIRECT FLUORESCENT
2 LAMP, TT5 BI-TUBE, 5 1/2" DEEP
MICROPERFORATED MESH LAMP SHIELD, STATIC

Photometry

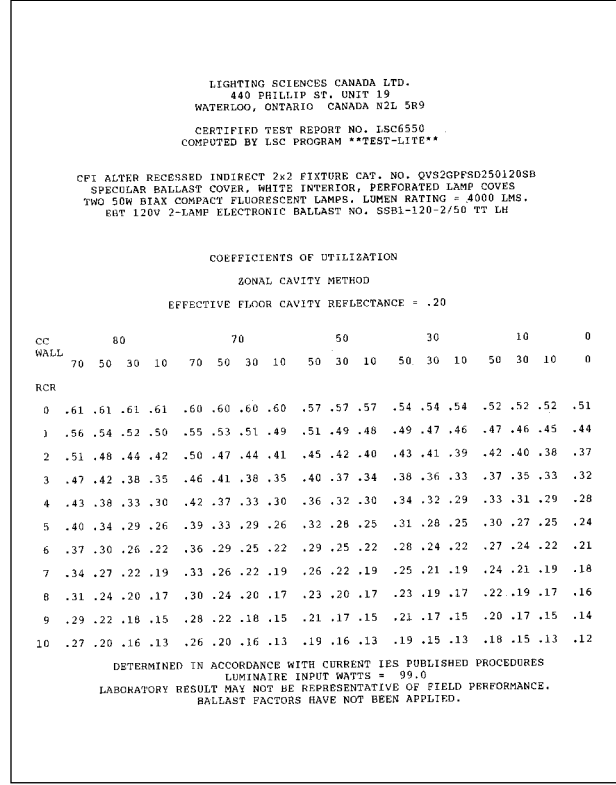
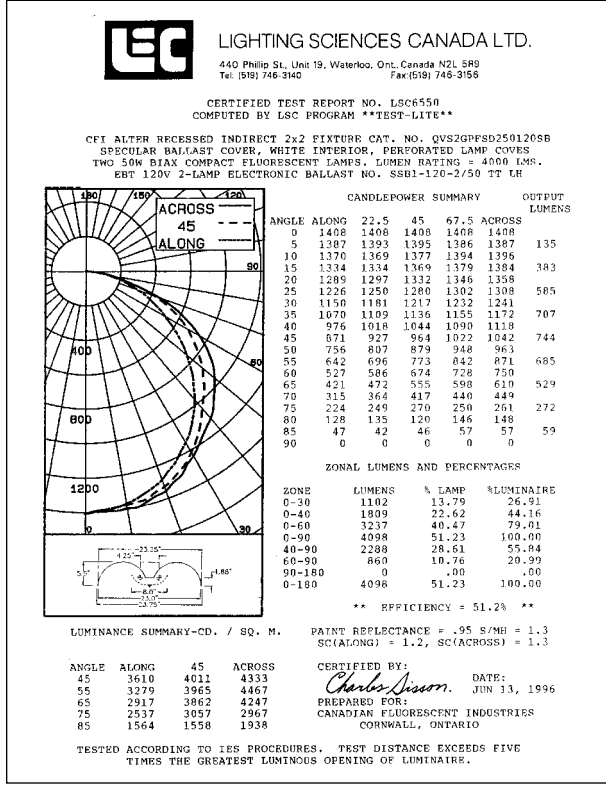

Ordering Information Explanation of Catalog Number Example: QVS2GPFOS2FT120BE

QVS QUALITY VISUAL STATIC Recessed direct indirect soft light optical system	2 FIXTURE WIDTH: 2'	G CEILING TYPE: Standard exposed T-grid ceilings	LAMP SHIELD: PF = Microperforated SD = Solid	LAMP QUANTITY 2	FT LAMP/FIXTURE LENGTH: (NOMINAL 24") FT = TT5 Bi-Tube	VOLTAGE: 120V 277V 347V	OPTIONS: R = Radio Interference Filter O = Emergency Lighting System (for Canada) N = Emergency Lighting System (for U.S.)
---	----------------------------------	---	---	---------------------------	--	---	--

BALLAST:
BE = 50W Electronic TT5 RS
BR = 40W Electronic TT5 RS
BX = 40W Magnetic TT5 RS
PB = 40W TT5 PowerSpec Dimming*
PC = 50/55W TT5 PowerSpec Dimming*
SB = 40W Generic Electronic TT5

*Not available in 347V.

Specifications

MATERIALS: One piece chassis constructed from die formed 20 gauge cold rolled steel. Reflectors - 95% reflectance baked white acrylic matte paint finish. Specular aluminum interior reflector. Soft white acrylic film on inside of lamp shield conceals lamp image.

FINISH: Chassis exterior - phosphate undercoating, baked white acrylic matte high reflectance paint finish.

ELECTRICAL: Rapid start HPF, thermally protected class "P" ballast (Bi-tube type). If K.O.s are within 3" of ballast use wire suitable for at least 90C.

LABELS: Listed by



Job Information

Type:

Lightolier a Genlyte Thomas Company www.lightolier.com

Technical Information: (978) 657-7600 • Fax (978) 658-0595

631 Airport Road, Fall River, MA 02720 • (508) 679-8131 • Fax (508) 674-4710

We reserve the right to change details of design, materials and finish.

© 2002 Genlyte Thomas Group LLC (Lightolier Division)

A0902

Section 5 / Folio L10-20

LIGHTOLIER