

Prismatic Lens

Fresnel Lens

Calculite® HID Lensed Downlight C7E17FL-PL

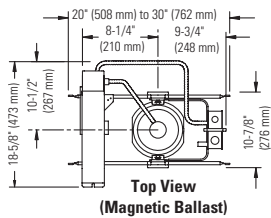

Top View (Magnetic Ballast)

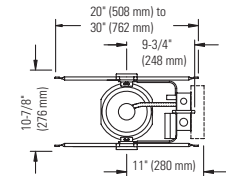

Top View (Electronic Ballast)

Ceiling Cutout: 8" (203mm) dia.

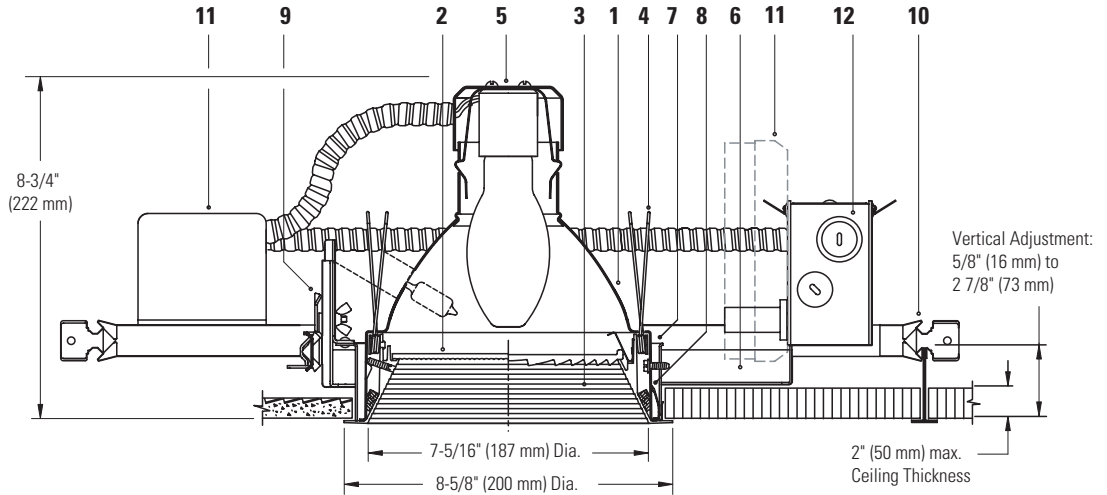

Reflector Trim	Frame-In Kit	Lamp (Coated, Ceramic MH)
C7E17LWHW Fresnel Lens, White Step Baffle, White Flange	C770MHE1 Electronic, 120V 70W ED17, BD17 (Enclosed)	C770MHE2 Electronic, 277V 70W ED17, BD17 (Enclosed)
C7E17PLWHW Prismatic Lens, White Step Baffle, White Flange	C710MHE1 Electronic, 120V 100W ED17, BD17 (Enclosed)	C710MHE2 Electronic, 277V 100W ED17 BD17 (Enclosed)
	C770MHU Magnetic, 120V/277V 70W ED17, BD1 (Enclosed)	C710MHU Magnetic, 120V/277V 100W ED17, BD17 (Enclosed)

Features

- Reflector:** Semi-Specular anodized aluminum, 16 ga. Removable from inside fixture for access to splices and ballast.
- Lens:** Prismatic (C7E17PLWHW) or Fresnel (C7E17LWHW) lens. Regressed 1 3/4" from ceiling line.
- Die-Cast Baffle:** Painted white, self flange, deep conical step baffle for low brightness, supports lens. Small Allen-head set screw provides secure attachment for use where vandal resistant luminaires are required.
- Torsionite Springs:** Permit removal of lens assembly without tools.
- Socket Cup:** Galvanized steel, pre-wired with medium base pulse rated socket. Snaps onto upper reflector for secure attachment without tools; unitized construction assures proper lamp alignment to optics for consistent performance.
- Mounting Frame:** 0.048" (18-ga.) galvanized steel includes pre-installed mounting bars.
- Mounting Ring:** 0.048" (18-ga.) galvanized steel. Designed for vertical adjustment from above or below for ceilings from 0" to 2" thick. Center-line notches allow consistent alignment of multiple fixtures.
- Retaining Springs:** Rust resistant simplify reflector housing removal for inspection and maintenance.
- Vertical Adjustment Mechanism:** Accommodates mounting to virtually any ceiling system using mounting bars (provided, or 1/2" EMT tubing (by others). Single locking feature secures all adjustments. Alignment holes and markings allow fixture to be preset prior to installation.
- Mounting Bars:** 0.048" (18-ga.) pre-installed, telescoping bars extend to 30" long and lock securely into position. Built-in locking tabs provide positive attachment to common T-bar systems. Self-centering feature simplifies installation in 24" O.C. grid systems. Attaches to steel or wood joists without accessories.
- Ballast:** Electronic 120V or 277V or dual voltage (120V/277V) magnetic. Assembly is accessible from below without tools for inspection and replacement.
- Junction Box:** 0.048" (18-ga.) galvanized steel. UL listed for 8 No. 12 AWG, 90°C through branch circuit conductors; allows inspection from below.
- Thermal Protector:** (not shown) Meets NEC and UL requirements. Do not install insulation above nor within 3" (76mm) of any part of the luminaire.

Electrical

Electronic Ballast: 120V or 277V, 50/60 Hz., encased, high-power factor, T.H.D. <15%, thermally and transient protected, RMI / RFI complies with FCC Part 18 non-consumer equipment, shut-down circuit at end of lamp life, sound rating "A", -5° F minimum starting temperature, Type 1 outdoor rating.

Ballast	ANSI Code	Voltage	Max. Amps	Input Watts
70W MH	M98/M143	120/277	0.67/0.28	78
100W MH	M90/M140	120/277	0.90/0.43	110

Magnetic Ballast: 120V/277V dual voltage, 60 Hz., encased and potted, HX-HPF circuit type, high power factor, sound rating "B", -20° F minimum starting temperature, Type 1 Outdoor rating.

Ballast	ANSI Code	Voltage	Max. Amps	Input Watts
70W MH	M98/M143	120/277	1.90/0.80	94
100W MH	M90/M140	120/277	2.40/1.10	125

Options and Accessories

Auxiliary: Add suffix **A** to Frame-In Kit and Reflector Trim. See Spec.Sheet "A/E"

Emergency Lamp: Add suffix **E** to FIK and Reflector Trim. See Spec.Sheet "A/E"

Slope Ceiling Adapters: See Specification Sheet SCA.

Fuse (magnetic ballast): Add suffix **F1** or **F2** to FIK (F1=120V F2=277V)

Chicago Plenum: Consult Factory.

Labels

UL (Suitable for Wet Locations), CSA, I.B.E.W.

Job Information	Type:
Job Name:	
Cat. No.:	
Lamp(s):	
Notes:	

LIGHTOLIER®

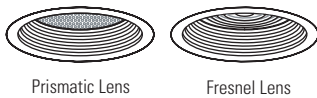

Prismatic Lens

Fresnel Lens

Calculite® HID Lensed Downlight C7E17FL-PL

FRESNEL LENS/WHITE BAFFLE - 70W ED17 (ENCLOSED), PHILIPS CERAMIC MH. LUMEN RATING = 6000 LMS., AROMAT ELECTRONIC BALLAST.

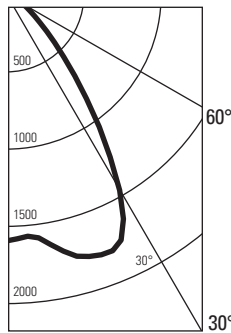

ANGLE	MEAN CP	LUMENS	LUMINANCE SUMMARY - CD. / SQ. M.
			ANGLE MEAN CD/SQ M
0	2368		45 24091
5	2318	219	55 12972
10	2183		65 7868
15	1988	561	75 3806
20	1759		85 1310
25	1497	689	
30	1202		
35	886	564	
40	617		
45	421	337	
50	283		
55	184	173	
60	121		
65	82	84	
70	51		
75	24	29	
80	11		
85	3	5	
90	0		

ZONAL LUMENS AND PERCENTAGES			
ZONE	LUMENS	% LAMP	% LUMINAIRE
0-30	1469	24.49	55.2
0-40	2033	33.89	76.39
0-60	2543	42.4	95.58
0-90	2661	44.36	100
40-90	628	10.47	23.61
60-90	117	1.96	4.42
90-180	0	0	0
0-180	2661	44.36	100

Coefficients of Utilization												
CEILING	80%				70%				50%		30%	
	70	50	30	10	50	10	50	10	50	10	0	
WALL	Zonal Cavity Method - Effective Floor Cavity Reflectance = 20%											
RCR	Zonal Cavity Method - Effective Floor Cavity Reflectance = 20%											
0	.53	.53	.53	.53	.52	.52	.49	.49	.47	.47	.44	
1	.50	.49	.48	.47	.48	.46	.46	.45	.44	.43	.41	
2	.48	.45	.44	.42	.45	.42	.43	.41	.42	.40	.38	
3	.45	.42	.40	.38	.41	.38	.40	.37	.39	.37	.35	
4	.43	.39	.37	.35	.39	.35	.38	.34	.37	.34	.33	
5	.40	.37	.34	.32	.36	.32	.35	.32	.35	.31	.30	
6	.38	.34	.31	.30	.34	.29	.33	.29	.33	.29	.28	
7	.36	.32	.29	.27	.32	.27	.31	.27	.30	.27	.26	
8	.34	.30	.27	.25	.29	.25	.29	.25	.29	.25	.24	
9	.32	.28	.25	.23	.28	.23	.27	.23	.27	.23	.22	
10	.31	.26	.23	.21	.26	.21	.25	.21	.25	.21	.21	

** EFFICIENCY = 44.4% **
 SC = .9
 CERTIFIED TEST REPORT NO. 2553FR, DATE: MAR 23, 2004
 COMPUTED BY LSI PROGRAM **TEST-LITE**

FRESNEL LENS/WHITE BAFFLE - 100W ED17 (ENCLOSED) COATED, CERAMIC MH, PHILIPS, LUMEN RATING = 9000 LMS., AROMAT ELECTRONIC BALLAST

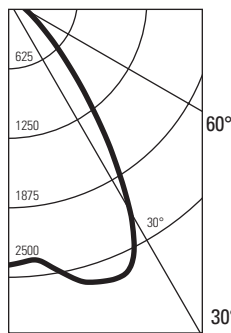

ANGLE	MEAN CP	LUMENS	LUMINANCE SUMMARY - CD. / SQ. M.
			ANGLE MEAN CD/SQ M
0	2391		45 37610
5	2355	228	55 19605
10	2464		65 12235
15	2630	738	75 4995
20	2688		85 1598
25	2629	1173	
30	2194		
35	1568	999	
40	1028		
45	658	535	
50	420		
55	278	261	
60	187		
65	128	129	
70	76		
75	32	41	
80	14		
85	3	6	
90	0		

ZONAL LUMENS AND PERCENTAGES			
ZONE	LUMENS	% LAMP	% LUMINAIRE
0-30	2139	23.77	52.06
0-40	3138	34.87	76.36
0-60	3934	43.71	95.74
0-90	4109	45.66	100
40-90	971	10.79	23.64
60-90	175	1.95	4.26
90-180	0	0	0
0-180	4109	45.66	100

Coefficients of Utilization												
CEILING	80%				70%				50%		30%	
	70	50	30	10	50	10	50	10	50	10	0	
WALL	Zonal Cavity Method - Effective Floor Cavity Reflectance = 20%											
RCR	Zonal Cavity Method - Effective Floor Cavity Reflectance = 20%											
0	.54	.54	.54	.54	.53	.53	.51	.51	.49	.49	.46	
1	.52	.50	.49	.48	.49	.47	.47	.46	.46	.44	.42	
2	.49	.47	.45	.43	.46	.42	.44	.42	.43	.41	.39	
3	.46	.43	.41	.39	.42	.38	.41	.38	.40	.37	.36	
4	.44	.40	.37	.35	.40	.35	.39	.35	.38	.34	.33	
5	.41	.37	.34	.32	.37	.32	.36	.32	.35	.31	.30	
6	.39	.35	.32	.30	.34	.29	.33	.29	.33	.29	.28	
7	.36	.32	.29	.27	.32	.27	.31	.27	.30	.26	.26	
8	.34	.30	.27	.25	.29	.25	.29	.25	.28	.24	.24	
9	.32	.28	.25	.23	.27	.23	.27	.22	.26	.22	.22	
10	.30	.26	.23	.21	.25	.21	.25	.21	.25	.21	.20	

** EFFICIENCY = 45.7% **
 SC = 1.1
 CERTIFIED TEST REPORT NO. 2566FR, DATE: MAR 24, 2004
 COMPUTED BY LSI PROGRAM **TEST-LITE**

PRISMATIC LENS/WHITE BAFFLE - 70W ED17 (ENCLOSED), PHILIPS CERAMIC MH. LUMEN RATING = 6000 LMS., AROMAT ELECTRONIC BALLAST

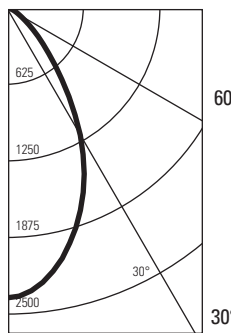

ANGLE	MEAN CP	LUMENS	LUMINANCE SUMMARY - CD. / SQ. M.
			ANGLE MEAN CD/SQ M
0	2368		45 24091
5	2318	219	55 12972
10	2183		65 7868
15	1988	561	75 3806
20	1759		85 1310
25	1497	689	
30	1202		
35	886	564	
40	617		
45	421	337	
50	283		
55	184	173	
60	121		
65	82	84	
70	51		
75	24	29	
80	11		
85	3	5	
90	0		

ZONAL LUMENS AND PERCENTAGES			
ZONE	LUMENS	% LAMP	% LUMINAIRE
0-30	1469	24.49	55.2
0-40	2033	33.89	76.39
0-60	2543	42.4	95.58
0-90	2661	44.36	100
40-90	628	10.47	23.61
60-90	117	1.96	4.42
90-180	0	0	0
0-180	2661	44.36	100

Coefficients of Utilization												
CEILING	80%				70%				50%		30%	
	70	50	30	10	50	10	50	10	50	10	0	
WALL	Zonal Cavity Method - Effective Floor Cavity Reflectance = 20%											
RCR	Zonal Cavity Method - Effective Floor Cavity Reflectance = 20%											
0	.53	.53	.53	.53	.52	.52	.49	.49	.47	.47	.44	
1	.50	.49	.48	.47	.48	.46	.46	.45	.44	.43	.41	
2	.48	.45	.44	.42	.45	.42	.43	.41	.42	.40	.38	
3	.45	.42	.40	.38	.41	.38	.40	.37	.39	.37	.35	
4	.43	.39	.37	.35	.39	.35	.38	.34	.37	.34	.33	
5	.40	.37	.34	.32	.36	.32	.35	.32	.35	.31	.30	
6	.38	.34	.31	.30	.34	.29	.33	.29	.33	.29	.28	
7	.36	.32	.29	.27	.32	.27	.31	.27	.30	.27	.26	
8	.34	.30	.27	.25	.29	.25	.29	.25	.29	.25	.24	
9	.32	.28	.25	.23	.28	.23	.27	.23	.27	.23	.22	
10	.31	.26	.23	.21	.26	.21	.25	.21	.25	.21	.21	

** EFFICIENCY = 44.4% **
 SC = .9
 CERTIFIED TEST REPORT NO. 2553FR, DATE: MAR 23, 2004
 COMPUTED BY LSI PROGRAM **TEST-LITE**

PRISMATIC LENS/WHITE BAFFLE - 100W ED17 (ENCLOSED) COATED, CERAMIC MH, PHILIPS, LUMEN RATING = 9000 LMS., AROMAT ELECTRONIC BALLAST

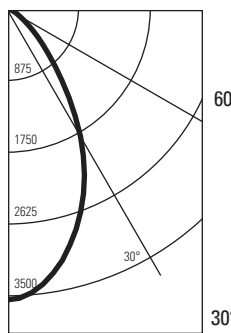

ANGLE	MEAN CP	LUMENS	LUMINANCE SUMMARY - CD. / SQ. M.
			ANGLE MEAN CD/SQ M
0	3550		45 36025
5	3476	329	55 19321
10	3272		65 11616
15	2980	841	75 5405
20	2636		85 1117
25	2243	1033	
30	1801		
35	1327	845	
40	924		
45	630	505	
50	423		
55	274	258	
60	180		
65	121	123	
70	75		
75	35	42	
80	15		
85	2	5	
90	0		

ZONAL LUMENS AND PERCENTAGES			
ZONE	LUMENS	% LAMP	% LUMINAIRE
0-30	2202	24.47	55.32
0-40	3046	33.86	76.54
0-60	3809	42.33	95.71
0-90	3980	44.23	100
40-90	933	10.38	23.46
60-90	170	1.9	4.29
90-180	0	0	0
0-180	3980	44.23	100

Coefficients of Utilization												
CEILING	80%				70%				50%		30%	
	70	50	30	10	50	10	50	10	50	10	0	
WALL	Zonal Cavity Method - Effective Floor Cavity Reflectance = 20%											
RCR	Zonal Cavity Method - Effective Floor Cavity Reflectance = 20%											
0	.53	.53	.53	.53	.51	.51	.49	.49	.47	.47	.44	
1	.50	.49	.48	.47	.48	.46	.46	.44	.44	.43	.41	
2	.47	.45	.43	.42	.44	.41	.43	.40	.42	.40	.38	
3	.45	.42	.40	.38	.41	.38	.40	.37	.39	.36	.35	
4	.43	.39	.37	.35	.39	.35	.38	.34	.37	.34	.33	
5	.40	.37	.34	.32	.36	.32	.35	.31	.35	.31	.30	
6	.38	.34	.31	.29	.34	.29	.33	.29	.32	.29	.28	
7	.36	.32	.29	.27	.31	.27	.31	.27	.30	.27	.26	
8	.34	.30	.27	.25	.29	.25	.29	.25	.28	.25	.24	
9	.32	.28	.25	.23	.27	.23	.27	.23	.27	.23	.22	
10	.30	.26	.23	.21	.26	.21	.25	.21	.25	.21	.21	

** EFFICIENCY = 44.2% **
 SC = .9
 CERTIFIED TEST REPORT NO. 2567FR, DATE: MAR 24, 2004
 COMPUTED BY LSI PROGRAM **TEST-LITE**

LIGHTOLIER®

Job Information Type:

Lightolier a Genlyte company www.lightolier.com
 631 Airport Road, Fall River, MA 02720 • (508) 679-8131 • Fax (508) 674-4710
 We reserve the right to change details of design, materials and finish.
 © 2005 Genlyte LLC • B0809